

Xerox 4050/4090/4450/4650 Laser Printing Systems Installation Planning

Xerox Corporation
701 S. Aviation Boulevard
El Segundo, CA 90245

© 1991, 1992, 1993, 1994 by Xerox Corporation. All rights reserved.

Copyright protection claimed includes all forms and matters of copyrightable material and information now allowed by statutory or judicial law or hereinafter granted, including without limitation, material generated from the software programs which are displayed on the screen, such as icons, screen displays, looks, etc.

Printed in the United States of America

Publication number: 720P92990

Xerox® and all Xerox products mentioned in this publication are trademarks of Xerox Corporation. Products and trademarks of other companies are also acknowledged.

Changes are periodically made to this document. Changes, technical inaccuracies, and typographic errors will be corrected in subsequent editions.

This document was created on the Xerox 6085 Professional Computer System using GlobalView software. The typeface is Optima.

Table of contents

Introduction	v
Related publications	vi
1. Preinstallation	1-1
Responsibilities	1-1
Xerox responsibilities	1-1
Customer responsibilities	1-2
Installation planning checklist	1-3
LPS space and delivery requirements	1-5
System controller	1-6
Printer	1-8
Clearance space requirements	1-13
Shared space	1-14
Efficiency of use	1-15
Delivery access requirements	1-16
Environmental and electrical requirements	1-18
4050	1-18
4090/4650	1-19
Cabling requirements	1-19
Cable locations	1-20
Cable lengths	1-20
Configuration options for the 180 Cartridge Tape System	1-20
Interface requirements	1-22
Channel-attached	1-22
Third-party connections	1-22
Connecting IBM host equipment	1-22
Connecting DEC equipment using XPMF-VMS	1-23
Possible configurations	1-23
Components	1-24
Installation responsibilities	1-25
Installation requirements	1-25
Hardware requirements	1-25
Software requirements	1-26
Documentation	1-26
Training	1-26

Fonts and supplies for installation	1-27
Fonts	1-28
Paper	1-29
Dry ink	1-30
Fuser lubricant	1-30
Developer	1-30
Floppy disks	1-30
Stitcher wire	1-30
Tapes	1-31
Space planning templates	1-31
2. Installation	2-1
Installation process	2-1
Installation responsibilities	2-1
3. Postinstallation	2-1
Xerox support services	3-1
Routine maintenance	3-2
Meter reading and reporting	3-2
Xerox Font Service	3-2
How to order fonts in the United States	3-2
How to order fonts in other countries	3-3
Ordering documentation and software	3-3
Xerox Supplies Order Service	3-3
How to order supplies	3-4
Consumable supplies table	3-5
Glossary	GLOSSARY-1
Index	INDEX-1

Introduction

The *Xerox 4050/4090/4450/4650 LPS Installation Planning* guide helps you prepare for delivery and installation of your new Xerox Laser Printing System (LPS). This is one of many manuals available with your new LPS. You received it first to help you plan for installation. You receive the complete reference set when your LPS is delivered.

This manual is intended for the person responsible for coordinating the installation of the printer at your site.

Along with descriptions of Xerox and Customer responsibilities, this guide provides the following information for each phase of installation:

Phase	Activities/concerns
Preinstallation	Space planning, electrical and environmental requirements, and connectivity information.
Installation	Customer: Supplies on site, system specialist available, operators available, document and software kits checked, and test jobs ready. Xerox: Installing the LPS, loading software and applications, setting interface parameters, training operators, and reviewing preventive maintenance schedules and service call procedures.
Postinstallation	Calling for service, scheduling routine maintenance procedure, and information on ordering supplies.

Related publications

You can find additional information related to the 4050/4090/4450/4650 LPS in the following publications.

Publication	Number
<i>Xerox 4050/4090/4450/4650 LPS Master Index</i>	720P93070
<i>Xerox 4050/4090/4450/4650 LPS Bypass Transport Instructions</i>	720P22320
<i>Xerox 4050/4090/4450/4650 LPS Bypass Transport Operator Training Guide Flipcharts Supplement</i>	720P22340
<i>Xerox 4050/4090/4450/4650 LPS Bypass Transport Operator Training Guide Supplement</i>	720P22330
<i>Xerox 4050/4090/4450/4650 LPS Command Reference</i>	720P23260
<i>Xerox 4050/4090/4450/4650 LPS Forms Creation Guide</i>	720P93060
<i>Xerox 4050/4090/4450/4650 LPS Forms Creation Quick Reference Card</i>	720P93100
<i>Xerox 4050/4090/4450/4650 LPS Message Guide</i>	720P93020
<i>Xerox 4050/4090/4450/4650 LPS Operator Guide</i>	720P93000
<i>Xerox 4050/4090/4450/4650 LPS Operator Instructor Training Flipcharts</i>	720P22080
<i>Xerox 4050/4090/4450/4650 LPS Operator Instructor Training Guide</i>	720P22070
<i>Xerox 4050/4090/4450/4650 LPS Operator Quick Reference</i>	720P93050
<i>Xerox 4050/4090/4450/4650 LPS Print Description Language (PDL) Quick Reference Card</i>	720P93090
<i>Xerox 4050/4090/4450/4650 LPS Print Description Language (PDL) Reference</i>	720P93030
<i>Xerox 4050/4090/4450/4650 LPS Product Reference</i>	720P93010
<i>Xerox 4050/4090/4450/4650 LPS System Administration Guide</i>	720P93040
<i>Xerox 4050/4090/4450/4650 LPS System Administration Quick Reference Card</i>	720P93080
<i>Xerox Standard Font Library Font User Guide</i>	600P86174
<i>Xerox Tape Formats Manual</i>	600P86175
<i>Helpful Facts About Paper</i>	610P50497

This chapter assists you in preparing for the installation of your Laser Printing System (LPS). Consult your sales representative for the requirements of any related equipment or communications devices that may have been ordered.

Responsibilities

A successful installation depends upon both you and Xerox. The sections that follow describe your responsibilities and the responsibilities Xerox has to you. Some areas overlap and are joint responsibilities. Your service representatives are available to discuss installation issues and to assist you in completing the site installation.

Xerox responsibilities

Xerox responsibilities prior to, during, and after installation are outlined in table 1-1. Some services are dependent on the amount of support purchased or included with your system.

Table 1-1. **Xerox responsibilities**

Site selection	<ul style="list-style-type: none"> • Assist in site selection • Inspect and improve site
Installation	<ul style="list-style-type: none"> • Schedule the delivery of your LPS • Monitor installation activities • Assist you in ordering supplies and fonts • Install the LPS • Configure your system parameters (4450/MRP)
Training	<ul style="list-style-type: none"> • Provide standard operator training • Assist in determining system and training needs • Assist in scheduling system and user training
Support	<ul style="list-style-type: none"> • Provide assistance and information, as needed, in the areas of: <ul style="list-style-type: none"> — Software capabilities — Selecting software options — Operations — Applications and forms development — Interface capabilities — Interface capabilities with third-party finishers
Service	<ul style="list-style-type: none"> • Review preventive maintenance schedules and service call procedures • Determine your needs and then set the wire percentage indicator on the printer control console (stitcher/stacker option) • Provide ongoing system maintenance • Resolve hardware/software problems.

Customer responsibilities

Your responsibilities prior to, during, and after installation are detailed in table 1-2.

Table 2-1. **Customer responsibilities**

<p>Activities</p>	<ul style="list-style-type: none"> • Identify the primary interface with Xerox • Select and prepare the site for LPS installation (including adequate power and air conditioning) • Obtain the necessary interfaces, cables, transceivers, phone lines, and so on, if connecting to other equipment • Plan for and schedule installation activities • Monitor progress for a successful installation • Provide space for hardware options • Work with your sales representative to determine requirements for initial applications • Work with your service representative to determine the “low wire” percent values to be displayed on the printer control console (stitcher/stacker option) • Select operators and system specialists, and schedule their training. <p>Notes:</p> <p>In a mixed environment where there are a variety of printing systems, discuss print quality differences with your service representative.</p> <p>Ensure that your system specialists are familiar with the operating system software specific to your LPS. Operating system software is not the same for all laser printing systems. If your system specialists are familiar with one operating system and you are converting to or adding another, they should learn the differences between the systems.</p>
<p>Training</p>	<p>Operator training is conducted at your site shortly after the LPS is installed. Operators receive hands-on instruction regarding printing jobs, maintenance, and problem solving. Xerox offers a number of workshops and self-paced courses that teach advanced skills, including Advanced Customer Training (ACT). Contact your sales representative for additional information about these courses, or call Xerox Customer Education at 1-800-445-5554. Refer to the “Training” section of this chapter.</p>
<p>Personnel</p>	<p>One or more people need to be assigned the following routine LPS tasks:</p> <ul style="list-style-type: none"> • Preventive maintenance and cleaning • Changing stitcher wire (with the stitcher/stacker option; performed by ACT-trained operators only) • Meter reading and reporting • Placing service calls for hardware problems and applications-related issues • Identifying and implementing new applications • Ordering additional fonts • Ordering supplies. <p>Refer to the “Postinstallation” chapter for information on these activities.</p>

Installation planning checklist

An installation planning checklist is provided to aid you in LPS installation planning. Table 1-3 summarizes the tasks that must be performed and when in the installation process they should occur.

Use the checklist as a guide for ensuring the successful installation of your LPS. Should you have any questions, contact your sales representative or local Xerox or Rank Xerox office.

- **Week** column shows the approximate time an activity should occur. The weeks shown relate to the installation date. For example, -4 is four weeks prior to installation.
- **Reference** column lists the chapter in this manual which provides detailed information for that activity.

Notes:

- Time frames shown are intended to serve only as guidelines. Consult your suppliers to determine exact lead times.
- Information on Xerox Print Management Facility—VMS Version (XPMF/VMS) installation requirements are located in this chapter.

Table 1-3. Installation planning checklist

Week	Tasks	Reference	Responsibility	Date completed
- 5	Sign up for Xerox Documentation and Software Service.	XDSS order form	Customer	_____
- 4	Order additional manuals, if needed.		Customer	_____
	Schedule LPS delivery.		Xerox	_____
	Identify systems specialists and schedule training.	Introduction	Customer/Xerox	_____
	Select the site.	Chapter 1	Customer/Xerox	_____
	Prepare the site: — Space requirements — Electrical requirements — Cabling — Environmental requirements (temperature, humidity, heat dissipation)	Chapter 1	Customer	_____

- 3	Call Xerox Font Services to request font samples.	Chapter 1	Customer	_____
	Order custom fonts and logos.		Customer	_____
- 2	Train user systems specialists.		Xerox	_____
	Schedule operator training.	Chapter 1	Customer/Xerox	_____
	Order licensed fonts and signatures.	Chapter 1	Customer	_____
	Order consumable supplies.	Chapter 3	Customer/Xerox	_____
	Minimum supplies requirements needed for installation: — Paper (2 cartons) — Developer (1 carton) — Fuser lubricant (2 cartons) — Dry ink (1 carton) Note: You should have at least one carton of each item on hand at all times.			_____

- 1	Inspect and approve the site.		Xerox	_____

Table 1-3. Installation planning checklist (continued)

Week	Tasks	Reference	Responsibility	Date completed
Installation	Ensure that supplies are available.	Chapter 2	Customer	_____
	Install the LPS.		Xerox	_____
	Have systems specialist on hand.		Customer	_____
	Install the primary application.		Customer/Xerox	_____
	Have test jobs available, if desired.		Customer	_____
	Have operators available for training.		Customer	_____
	Train operators.		Xerox	_____
	Check the documentation kit.		Customer	_____
Review preventive maintenance schedules and service call procedures.	Xerox	_____		
Post-installation	Provide ongoing system maintenance.	Chapter 3	Customer	_____
	Establish supply and maintenance procedures.		Customer	_____
	Identify additional applications.	Chapter 3	Customer/Xerox	_____
	Order additional fonts and documentation.	Chapter 3	Customer	_____

LPS space and delivery requirements

Dimensions and weights of the LPS system controller and printer are listed in this chapter, along with diagrams to help you visualize their sizes and total space requirements.

Note: There must be a 78 inch/1,981.2 mm vertical clearance throughout the entire area. In addition, your LPS must be installed in a fixed location with a minimum clearance space of 36 inches/914 mm around all sides of each piece of equipment for access by Xerox service representatives.

Space planning templates, a space planning template transparency, and a grid are provided at the end of this chapter to assist you in planning the placement of your LPS. Contact your service representative if you have questions not specifically addressed in this guide.

The following diagrams represent top views of the components, surrounded by the required 36-inch/914 mm clearance on all sides.

System controller

This section provides the dimensions for the system controller.

System controller dimensions

The dimensions of the 4050/4090/4450/4650 system controller are as shown in table 1-4.

Table 1-4. **Dimensions**

Width:	48 inches/1,219 mm
Depth:	28.5 inches/723 mm
Height:	41 inches/1,041 mm
Weight:	430 pounds/195 kg
Total space requirement:	120 inches/3,048 mm by 100.5 inches/2,552 mm

Figure 1-1. **Space requirements**

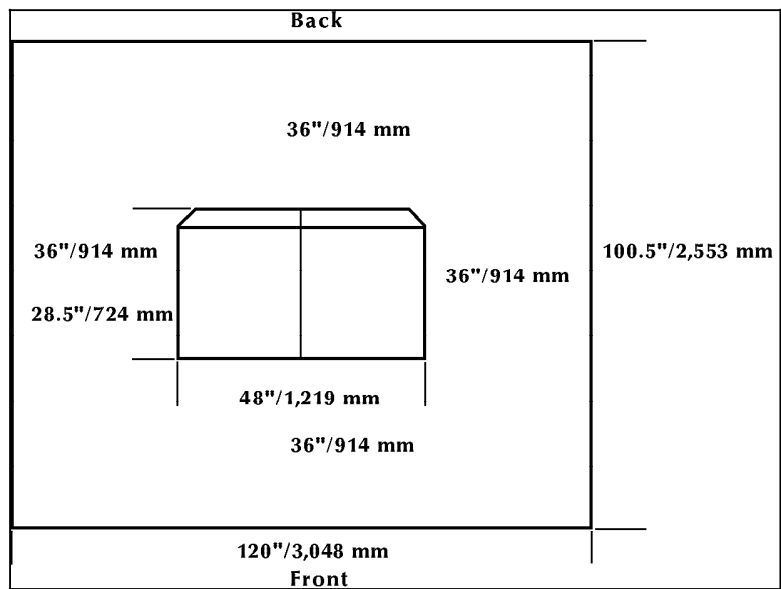

System controller with 9-track magnetic tape drive dimensions

The 9-track magnetic tape drive sits on top of the 4050, 4090, 4450, or 4650 system controller and has no additional width or depth requirements.

Its height and weight, however, may be important considerations. When calculating the 78-inch/1,981 mm height clearance for the system controller, make sure you add 32.5 inches/825 mm for the 9-track magnetic tape drive.

Note: When viewed from the front, the magnetic tape drive is positioned on the top of the right half of the 4050 system controller and on the top of the left half of the 4090/4650 system controller.

Its weight should also be factored into the LPS total weight.

Dimensions of the 4050/4090/4650 system controller with the 9-track magnetic tape drive measurements are shown in table 1-5.

Table 1-5. **Dimensions**

Width:	24 inches/609 mm
Depth:	23 inches/584 mm
Height:	73.5 inches/1,866 mm
Weight: System controller:	430 pounds/195 kg
9-track magnetic tape drive:	196 pounds/88.9 kg

Printer

This section provides the dimensions for the following configurations available for your 4050/4090/4450/4650 printer:

- Dual feeder with dual stacker
- Dual feeder with stitcher/stacker
- High-capacity feeder with dual stacker
- High-capacity feeder with stitcher/stacker.

Printer with dual feeder and dual stacker dimensions

The dimensions of the printer with the dual feeder and the dual stacker are shown in table 1-6.

Table 1-6. **Dimensions**

Width:	91.5 inches/2,324 mm
Depth:	34.5 inches/876 mm
Height:	41 inches/1,041 mm
Weight:	Printer: 1,046 pounds/474.5 kg Dual stacker: 226 pounds/102.5 kg Total: 1,272 pounds/577 kg
Total space requirement:	163.5 inches/4,152 mm by 106.5 inches/2,705 mm

Figure 1-2. **Space requirements**

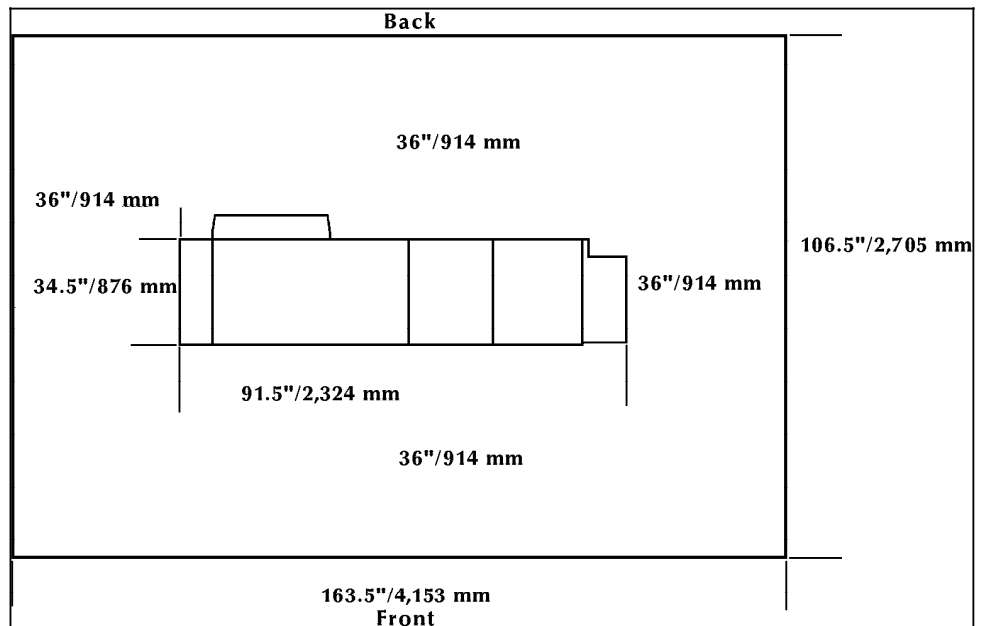

Printer with dual feeder and stitcher/stacker dimensions

The dimensions of the printer with the dual feeder and the stitcher/stacker are shown in table 1-7.

Table 1-7. **Dimensions**

Width:	89.5 inches/2,273 mm
Depth:	34.5 inches/876 mm
Height:	41 inches/1,041 mm
Weight:	Printer: 1,046 pounds/474.5 kg Stitcher/stacker: 228 pounds/103.4 kg Total: 1,274 pounds/577.9 kg
Total space requirement:	161.5 inches/4,102 mm by 106.5 inches/2,705 mm

Figure 1-3. **Space requirements**

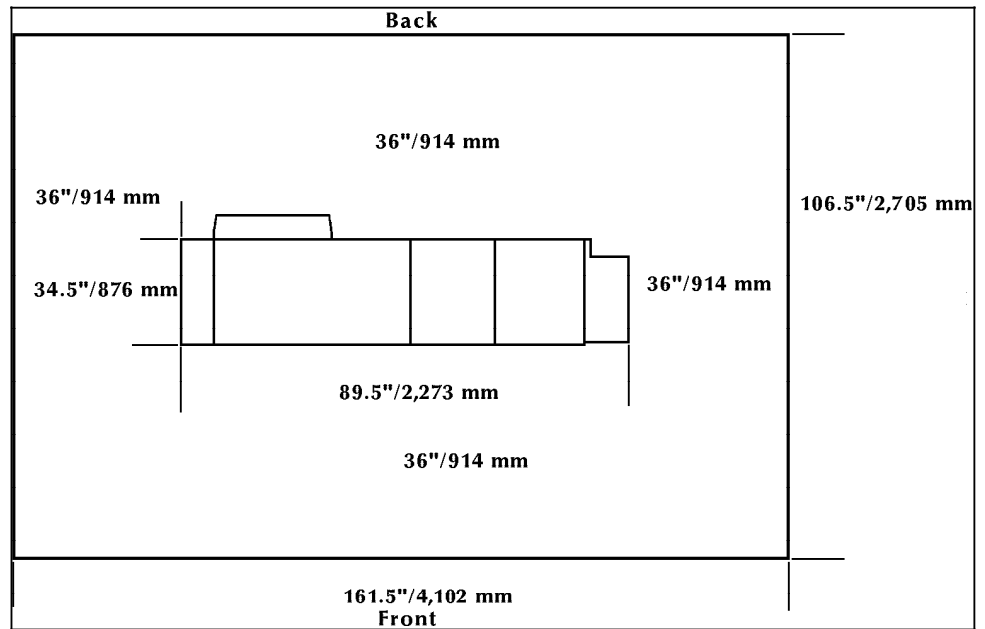

Printer with high-capacity feeder and dual stacker dimensions

The dimensions of the printer with the high-capacity feeder and the dual stacker are shown in table 1-8.

Table 1-8. **Dimensions**

Width:	114 inches/2,895 mm
Depth:	34.5 inches/876 mm
Height:	41 inches/1,041 mm
Weight:	Printer: 1,046 pounds/474.5 kg Dual stacker: 226 pounds/102.5 kg High-capacity feeder: 288 pounds/130.6 kg Total: 1,560 pounds/707.6 kg
Total space requirement:	186 inches/4,724 mm by 106.5 inches/2,705 mm

Figure 1-4. **Space requirements**

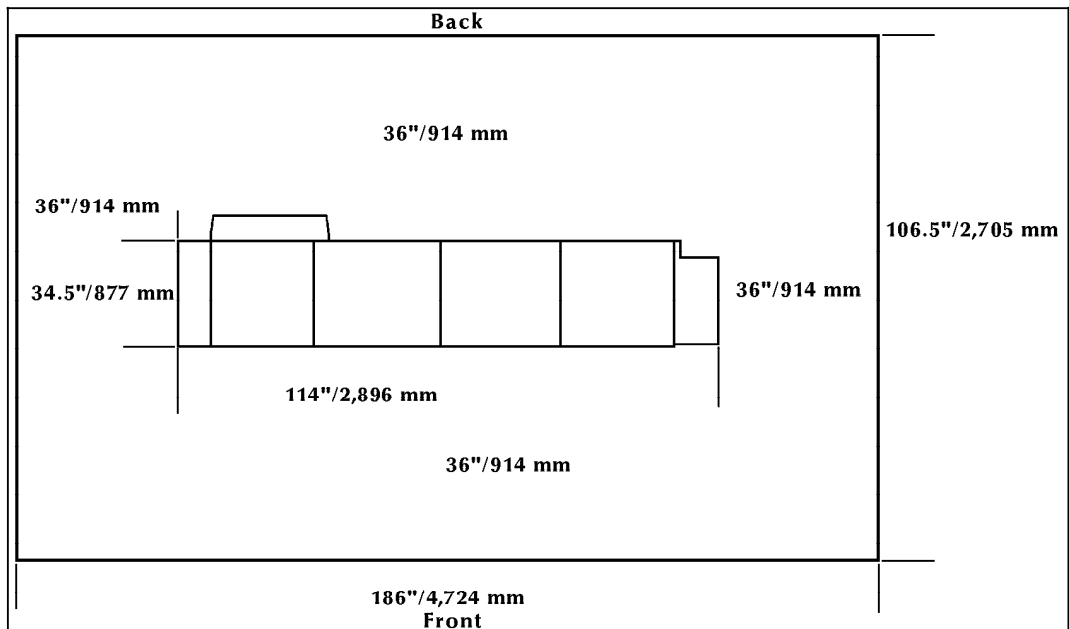

Printer with dual stacker and bypass transport dimensions

The dimensions of the printer with the bypass transport and the dual stacker are shown in table 1-10.

Table 1-10. **Dimensions**

Width:	95 inches/2,413 mm
Depth:	34.5 inches/876 mm
Height:	41 inches/1,041 mm
Weight:	Printer: 1,046 pounds/474.5 kg Bypass Transport: 35 pounds/15.9 kg Dual Stacker: 226 pounds/102.5 kg Total: 1,307 pounds/592.9 kg

Figure 1-6. **Space requirements**

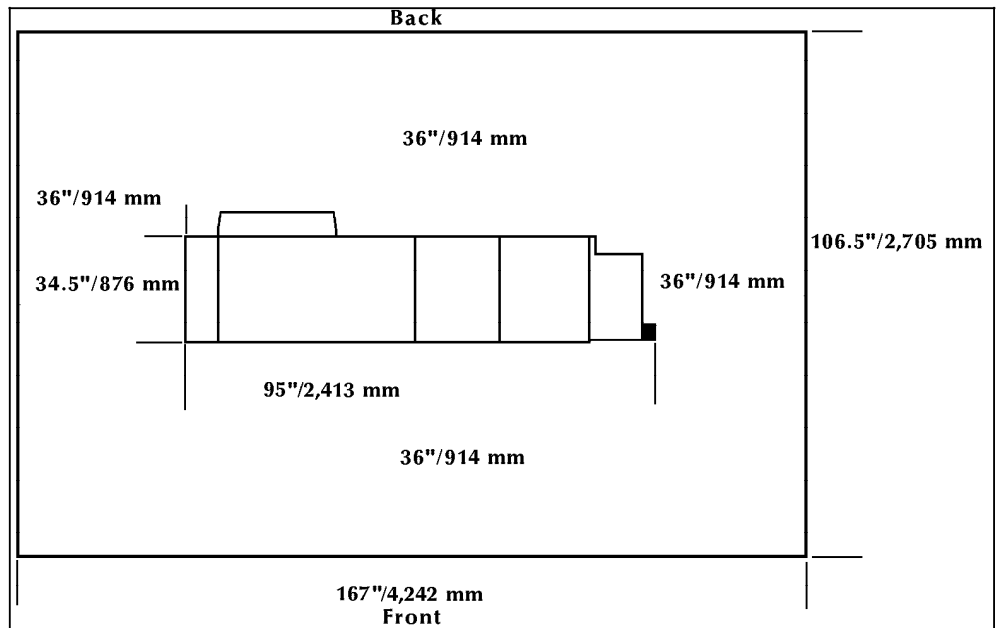

Printer with high-capacity feeder, dual stacker, and bypass transport dimensions

The dimensions of the printer with the high-capacity feeder, dual stacker, and bypass transport are shown in table 1-11.

Table 1-11. **Dimensions**

Width:	116 inches/2,947 mm
Depth:	34.5 inches/876 mm
Height:	41 inches/1,041 mm
Weight:	Printer: 1,046 pounds/474.5 kg
	Bypass Transport: 35 pounds/15.9 kg
	High-capacity feeder: 288 pounds/130.6 kg
	Dual stacker: 226 pounds/102.5 kg
	Total: 1,595 pounds/723.5 kg

Figure 1-7. **Space requirements**

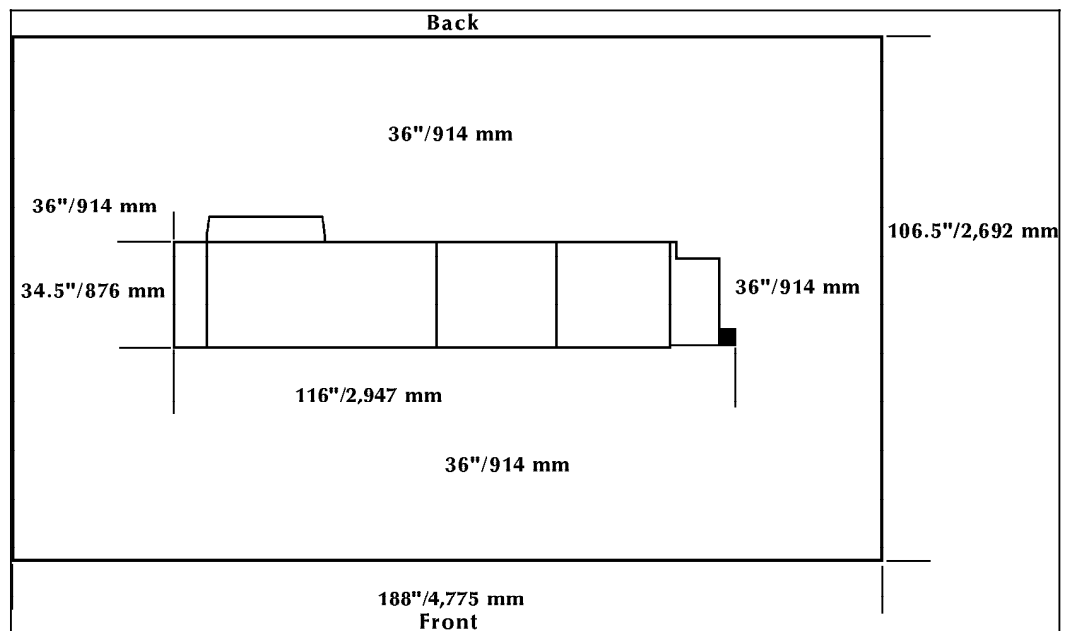

Clearance space requirements

Your LPS must be installed in a fixed location and meet the clearance requirements shown in table 1-12.

Table 1-12. **Clearance space requirements**

Clearance location	Requirements
All sides of each component	36 inches/914 mm
Vertical clearance throughout the entire area	78 inches/1,981 mm
Front operator area for each component	24 inches/609 mm

Shared space

It is always best to provide the full amount of clearance space around your LPS. It is sometimes necessary, however, to have shared space between components, such as between the printer and the system controller, or between the 4050, 4090, 4450, or 4650 LPS and another printing system. It is possible to share the 36 inch/914 mm clearance space around each component, but there are three rules which must always be observed:

- Space may be shared only with other Xerox equipment.
- Components may share the 36 inch/914 mm general service clearance areas, but they may not share the 24 inch/609 mm operator area in front of each component.
- There must be 78 inches/1,981 mm of vertical clearance throughout the entire area.

Figures 1-8 and 1-9 illustrate two possible configurations of shared space. In the first illustration, two printers are back to back. Because there is no operator area to be concerned with, the entire 36 inches/914 mm of general service space may be shared.

Figure 1-8. **Back-to-back shared service area space**

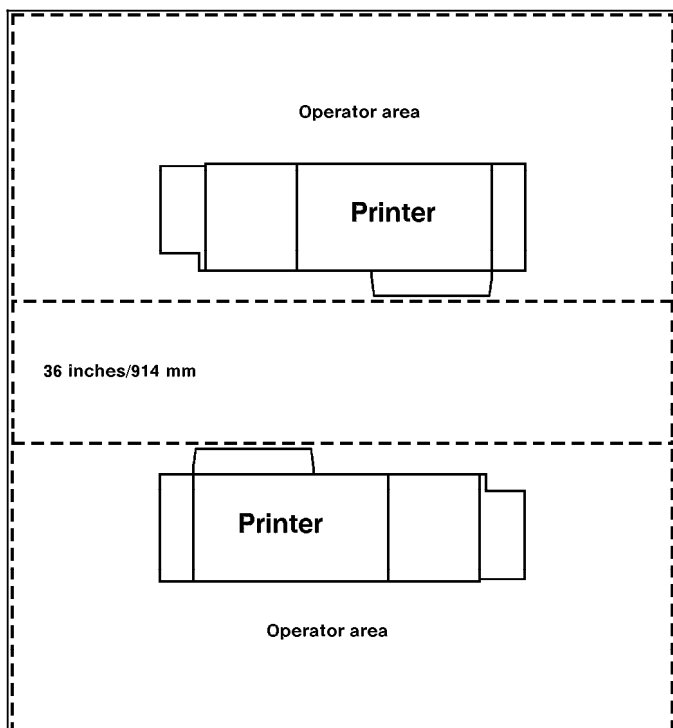
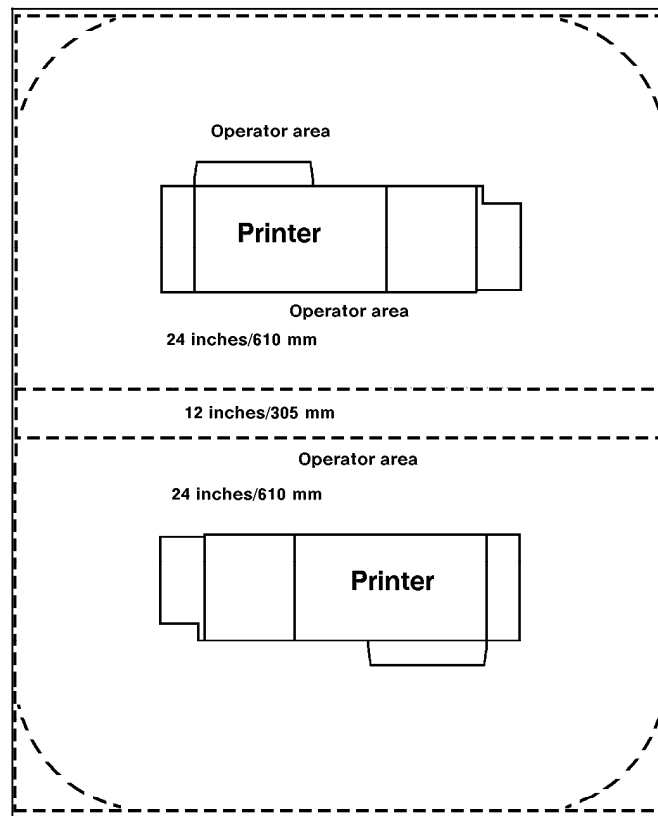

Figure 1-9 shows the two printers facing each other. The printers share 12 inches/305 mm of the general service space but not the exclusive operator area in front of each printer. Therefore, the printers must be 24 inches/610 mm + 24 inches/610 mm + 12 inches/305 mm apart: the entire operator space for each printer plus the shared general service area of 12 inches/305 mm.

Figure 1-9. Face-to-face shared service area space



Terminal

Requirements for the terminal follow:

- Terminal must sit within 15 ft/4.6 m of the system controller (usually directly on it).
- Power source (wall or under flooring) for the terminal must be within the maximum 15-ft/4.6 m length of the power cord.

Note: To ensure the safety of service personnel during maintenance and service, the terminal must be in the same room as the printer and in direct line of sight with it.

Efficiency of use

There are many possible layouts for your LPS. Placement depends on the type and amount of equipment and the size and shape of the room used to house the equipment. Some possible configurations for LPS components include:

- Side by side
- L-shaped
- Face to face.

Equipment placement should limit operator movements as much as possible. Here are a few suggestions that may be helpful:

- Place the system controller as close to the output end of the printer as possible. This enables operators to reach over to collect and check printed output.
- Consider the location of supplies in relation to the placement of the equipment. For example, having paper as close to the printer as possible saves time.
- Placing the system controller as close to offline interface devices saves time when monitoring tapes, jobs, and so on.

Delivery access requirements

It is easy to overlook how the equipment is going to get from the truck to the operation site.

- Does it need to go up stairs?
- Do you have an elevator if it will be located above the first floor?
- Is the elevator large enough?
- How wide are the hallways and the doorways?
- Do you have a loading dock or a specific door to which the equipment should be delivered?

All these issues must be reviewed prior to or at the time of the site inspection that is performed by your service representative.

The equipment dimensions are specified earlier in this chapter, so it is easy to know whether your hallways and doorways are wide enough to permit travel through them.

Turning radius

The width of the passageway where the equipment must negotiate a corner, whether into a room (or elevator) or into another passageway, must also be considered.

There are L-shaped turns and T-shaped turns. The diagrams and tables that follow show the minimum space needed to maneuver through the turns. To use the tables, measure the passage or doorway width into which you want to move at its minimum width. This is Passage A. Find that number (or the next higher number) on the appropriate table (table 1-13 or 1-14) and read across to the corresponding minimum value for Passage B, depending on the type of turn the equipment must negotiate. Figure 1-10 shows the two types of turns.

Figure 1-10. **L-shaped and T-shaped turns**

Table 1-13. Turning radius for the system controller

If passage or doorway A is:	Passage B must be (either turn):
30 inches/762 mm	51 inches/1,295 mm
31 inches/787 mm	49 inches/1,244 mm
32 inches/812 mm	48 inches/1,219 mm
34 inches/863 mm	45 inches/1,143 mm
36 inches/914 mm	42 inches/1,066 mm
38 inches/965 mm	40 inches/1,016 mm
40 inches/1,016 mm	38 inches/965 mm
42 inches/1,066 mm	36 inches/914 mm

Table 1-14. Turning radius for the printer

If passage or doorway A is:	Passage B for an L-turn must be:	Passage B for a T-turn must be:
29 inches/736 mm	68.6 inches/1,742 mm	67.6 inches/1,717 mm
30 inches/762 mm	66.2 inches/1,681 mm	65.7 inches/1,668 mm
31 inches/787 mm	64.2 inches/1,630 mm	63.9 inches/1,623 mm
32 inches/812 mm	62.3 inches/1,582 mm	62.2 inches/1,579 mm
33 inches/838 mm	60.7 inches/1,541 mm	60.6 inches/1,539 mm
34 inches/863 mm	59.1 inches/1,501 mm	59.1 inches/1,501 mm
35 inches/889 mm	57.7 inches/1,465 mm	57.7 inches/1,465 mm
36 inches/914 mm	56.3 inches/1,430 mm	56.3 inches/1,430 mm
37 inches/939 mm	55.2 inches/1,402 mm	55.2 inches/1,402 mm
38 inches/965 mm	54.0 inches/1,371 mm	54.0 inches/1,371 mm
39 inches/990 mm	52.9 inches/1,343 mm	52.9 inches/1,343 mm
40 inches/1,016 mm	51.8 inches/1,315 mm	51.8 inches/1,315 mm
41 inches/1,041 mm	50.5 inches/1,282 mm	50.5 inches/1,282 mm
42 inches/1,066 mm	49.8 inches/1,264 mm	49.8 inches/1,264 mm

Environmental and electrical requirements

This section provides important environmental and electrical requirements for your LPS that must be accommodated.

4050

Environmental and electrical requirements for the 4050 LPS are provided in table 1-15 and 1-16.

Table 1-15. **Environmental requirements**

Operating temperature	Normal: 68° F to 76° F/20° C to 24° C Minimum: 60° F/16° C Maximum: 80° F/27° C
Humidity	Normal: 45 +/- 10% Minimum: 30% Maximum: 60%
Heat dissipation, online	Operating: 15,000 BTU per hour Standby: 7,500 BTU per hour
Heat dissipation, offline	Operating: 15,500 BTU per hour Standby: 8,000 BTU per hour

Table 1-16. **Electrical requirements**

System controller	120/208 or 120/240 VAC; 50/60 Hz, 30 amp service, NEMA L14-30R 1.5 KVA both in standby mode and when operating Note: Magnetic tape unit assumed (maximum draw)
Printer	U.S./Canada, 60 Hz: 120/208 or 120/240 VAC; 30 amp service, NEMA 14-30R .875 KVA in standby, 3.1 when operating International, 50 Hz: 220/240 VAC or 380 VAC
Agency certification	UL, CSA, IEC

4090/4650

The environmental and electrical requirements for the 4090 and 4650 LPS are listed in tables 1-17 and 1-18

Table 1-17. **Environmental requirements**

Operating temperature	Normal: 68° F to 76° F/20° C to 24° C Minimum: 60° F/16° C Maximum: 80° F/27° C
Humidity	Normal: 45 +/- 10% Minimum: 30% Maximum: 60%
Heat dissipation, online	Operating: 15,000 BTU per hour Standby: 7,500 BTU per hour
Heat dissipation, offline	Operating: 15,500 BTU per hour Standby: 8,000 BTU per hour

Table 1-18. **Electrical requirements**

System controller	120/208 or 120/240 VAC; 50/60 Hz, 20 amp service, NEMA L14-20R 1.8 KVA both in standby mode and when operating Note: Magnetic tape unit assumed (maximum draw)
Printer	U.S./Canada, 60 Hz: 120/208 or 120/240 VAC; 20 amp service, NEMA 14-30R .875 KVA in standby, 3.1 when operating International, 50 Hz: 220/240 VAC or 380 VAC
Agency certification	UL, CSA, IEC

Cabling requirements

The printer and the system controller can be separated by up to 25 ft/7.6 m. The system controller is delivered with a 50 ft/15.5 m interface cable and a 14 ft/4.3 m, 220 VAC power cable. The printer is delivered with a 10 ft/3 m, 220 VAC power cable.

The power cable for the terminal is 15 ft/4.7 m long. The terminal must sit within 15 ft/4.7 m of the system controller, if not directly on it. The power source (wall or beneath flooring) for the terminal must be within the maximum 15 ft/4.7 m length of the power cable.

Note: To ensure the safety of the service representative during maintenance and service of the equipment, the terminal must be in the same room as the printer and in direct line of sight of the printer.

Cable locations

To run the cables effectively beneath the flooring, it is necessary to know where the cables enter and exit the printer and the system controller. Figure 1-11 shows those locations (marked with an X).

Figure 1-11. Cable enter/exit locations

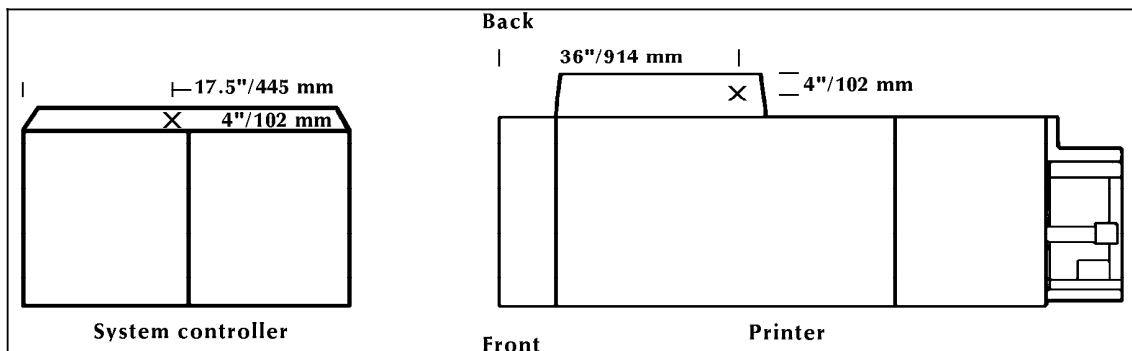

Cable lengths

Cable lengths are important considerations in planning your LPS layout, as components cannot be separated by more than the recommended cable distances. The distances affect the placement of the printer, system controller, and terminal.

Note: There are also distance requirements for some LPS options. Consult with your sales or service representative for these requirements.

Printer and system controller

Information on the cable lengths of the system controller and printer follow:

- Printer and system controller can be separated by up to 25 ft/7.6 m.
- Printer is delivered with a 10 ft/3 m power cable.
- System controller is delivered with a 14 ft/4.3 m power cable and a 50 ft/15.2 m interface cable.

Configuration options for the 180 Cartridge Tape System

The following are several configuration options for placement of the 180 Cartridge Tape System (CTS) and your 4050/4090/4650 LPS. The 180 CTS option does not apply to the 4450 LPS.

- Offline and switchable (online and offline)
- Online only
- Dual channel—offline and switchable
- Dual channel—online only.

Figures 1-12 to 1-15 illustrate these configurations.

Figure 1-12. 180 CTS offline and switchable configurations

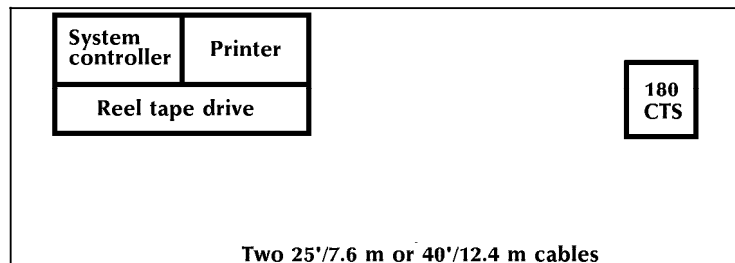

Figure 1-13. 180 CTS online only configuration

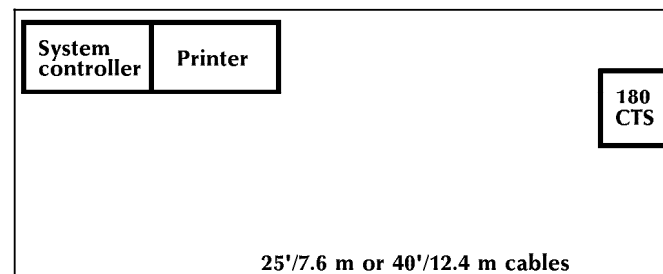
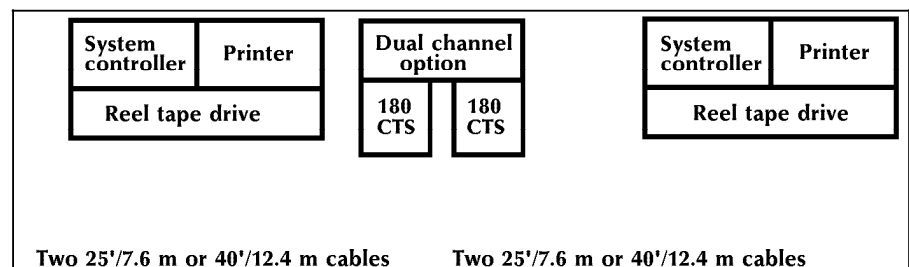

Figure 1-14. 180 CTS dual channel option: offline and switchable configurations



Notes:

All printers have online only capability.

Two printers are sharing one 180 CTS with a second transport.

There are two possible cable configurations:

- 40 ft cable from the LPS to the 180 CTS, with 25 ft cables connecting other components
- 25 ft cable from the LPS to the 180 CTS, with 15 ft cables connecting the LPS to the switchbox and a 25 ft cable connecting the 180 CTS to the switchbox.

Figure 1-15. **180 CTS dual channel option: online only configuration**

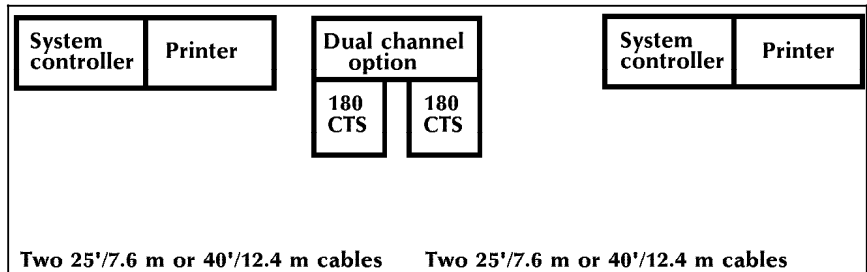

Notes:

All printers have online only capability.

Two printers are sharing one 180 CTS with a second transport.

Two 25 ft/7.6 m cables or two 40 ft/12.4 m cables connect the printers with the 180 CTS transports.

Interface requirements

This section describes requirements for the various interface environments.

Channel-attached

For an online configuration with an IBM host system, supply the following cables:

- Bus and tag cables (bus in, bus out, tag in, tag out)
- Emergency Power Off (EPO) cable (optional)
- Terminators (if necessary, due to location on channel).

For your convenience, it is possible to purchase the bus and tag cables for the printer through Xerox. Contact your Xerox sales representative for current pricing and order information.

Third-party connections

Xerox supports a number of third-party connections. For product recommendations and ordering information, contact The Xerox Connection.

Reference

Refer to the back of this manual for information regarding The Xerox Connection.

Connecting IBM host equipment

If you have an existing Xerox LPS installed and are communicating with an IBM host environment, you may have an 871 Communications Module installed. You may continue to use that device for connection to the LPS.

If this is your first Xerox LPS installation, The Xerox Connection may recommend the BARR/SNA device. This is a PC-based device that enables printing of host datastreams from a remote site, 3270 emulation to network users, and allows transfer of large files from your host environment to the LPS.

Contact The Xerox Connection for additional information on either of these interface products or for a suitable recommendation for your particular environment. The Xerox Connection can provide you with statistics and installation requirements for any recommended interface product.

Connecting DEC equipment using XPMF-VMS

The Xerox Print Management Facility (XPMF) is an interconnect product that includes the hardware, software, and documentation necessary to link your LPS with various Digital Equipment Corporation (DEC) VAX and micro VAX systems. General installation guidelines are described below. Contact your Xerox sales representative.

Reference

Refer to the *Xerox Print Symbiont Installation Guide* for additional information on this interconnect product.

XPMF is composed of three elements:

- Hardware components installed on the Xerox printer (by Xerox personnel)
- Appropriate DEC synchronous communications controller, modems, and communications line installed on the DEC VAX (by DEC personnel)
- XPMF-VMS software installed on the VAX/VMS system (by you).

The host software module included in the XPMF package is specifically designed for compatibility with the Digital Electronic Corporation VMS operating system. The UNIBUS communications controller is compatible with the communications controllers of each of the following DEC bus-type environments:

- UNIBUS
- VAXBI
- Q-bus.

Possible configurations

There are a number of possible configurations, including:

- Single or multi-user standalone environments with a single processor. Terminals are connected to the processor using a DEC connectivity device.

- Two or more standalone systems can be linked together to enable the transfer of information between systems using two processors. With a modem and the appropriate communications controller installed in one of the DEC processors, data from another processor can be submitted to the LPS using that processor.
- DEC systems may be located in different geographic locations. Standard telephone lines form the communications network across town or cities. The linkage for the LPS remains the same: the appropriate DEC communications controller, XPMF/VMS software in the host processor, and XPMF/VMS hardware in the LPS.
- Terminals, processors, and other devices may be linked in a Local Area Network (LAN) using Ethernet. The LPS is connected using the communications controller linked to one of the host processors (the "client") in the LAN. As a result, all processors connected to the Ethernet network access the LPS through the client processor. A modem is used to transmit print data to the printer.
- Wide Area Network (WAN) connects sites or multi-vendor systems that may be located around the world. Independent of the complexity of the network configuration, the connectivity to the LPS remains the same.
- VAX systems and intelligent storage controllers may be clustered. In a VAX cluster system, the various devices are connected to a common distribution unit, such as an SC008 Star Coupler. Each processor operates independently, with common access to the various storage elements connected to the intelligent I/O controllers (servers). The result is the linkage of numerous computer resources that appear to the user as a single system. Print data is transmitted from the cluster to the LPS using a modem.

Note: The modem is optional if your LPS is within 50 ft/15.2 m of the DEC processor.

Components

Table 1-19 describes the hardware and software components your LPS requires when connecting to DEC equipment.

Table 1-19. **Components**

Hardware	The hardware interface residing in the LPS is the DMR11 Synchronous Controller. It is installed into the LPS system controller with an adapter kit and cable supplied by Xerox.
Software	The XPMF/VMS interface is supported by Xerox software on both the LPS and the VAX system. The VAX-resident software performs the print supervisor (symbiont) role in the DEC print architecture and enhances the uses of the LPS. Refer to the <i>Xerox Print Management Facility—VMS Version Installation Guide</i> for additional information on the installation of this software.

Installation responsibilities

The following explains Xerox and customer responsibilities.

Table 1-20. **Installation responsibilities**

Xerox	<ul style="list-style-type: none"> • Install the hardware component of the XPMF/VMS interface. • Assist you, if necessary, in installing the software component. • Provide the XPMF/VMS interconnect kit.
Customer	<ul style="list-style-type: none"> • Arrange for telephone lines and modems to be installed, if required by your interconnect configuration. • Verify kit contents to make sure all necessary items are included. • Install the host-resident software component (part of the XPMF/VMS kit provided by Xerox) onto the VMS system. • Obtain all necessary hardware and software to form the selected connection solution. • Coordinate the installation steps that involve both DEC and Xerox service organizations. • Produce specifications for XPMF/VMS during the configuration of the printer. • Install any communications controller components needed for the DEC VAX system that submits jobs to the LPS.

Installation requirements

Before installing the host-resident software, you must have the following privileges and resources available:

- SETPRV privilege, or CMKRNL, WORLD, and SYSPRV privileges
- Minimum of 1,000 blocks of free disk space during installation; 500 blocks after installation.

Hardware requirements

Listed below are the three VAX/VMS systems that support the VAX-resident print supervisor (symbiont) software and the requirements for each.

Note: Appropriate communication cables and modems may be required. Consult your sales representative.

Table 1-21. **Hardware requirements**

System	Requirements
VMS/UNIBUS	<ul style="list-style-type: none"> Supported VAX series hardware configuration (CPU, memory, peripherals) with UNIBUS I/O subsystem DMR11-M synchronous interface and cabinet kit.
VMS/VAXBI	<ul style="list-style-type: none"> Supported VAXBI series hardware configuration (CPU, memory, peripherals) DSB32-AA synchronous interface and cabinet kit.
VMS/Q-bus	<ul style="list-style-type: none"> Supported MicroVAX hardware configuration (CPU, memory, peripherals) DSV11 Q-bus synchronous interface and cabinet kit.

Software requirements

The VAX-resident print supervisor (symbiont) software requires the following supported software:

- VMS Version 5.0 (or later)
- VAX Wide Area Device driver.

Documentation

References

A number of reference manuals are available to assist you in maximizing the productivity of your LPS. The reference set for your LPS is delivered with the equipment at installation. All of the manuals may be ordered as a set or individually.

Refer to the "Ordering documentation and software" section of the "Postinstallation" chapter for procedures on how to order additional documentation and the *Xerox Customer Documentation Catalog*.

Training

This section describes the training available through Xerox.

Operator training

Operator training is conducted at your location shortly after your LPS is installed. Training takes approximately four to seven hours, depending on the system configuration, and includes hands-on practice running basic jobs, maintenance, and problem solving. Determine the number of operators you want to attend the initial training, and schedule training dates and costs through your sales representative and system analyst.

Advanced Customer Training (ACT) is available at the Xerox training center in Leesburg, Virginia. Discuss candidates for this training with your sales representative, if desired. Keep in mind that operators should not be considered for ACT until they have

spent several months working with the LPS and have shown good mechanical aptitude. Call Xerox Customer Education at 1-800-445-5554 to schedule ACT.

System training

Several training workshops and a self-study course are included in the LPS technical training curriculum. Workshops are designed to provide a system overview, as well as forms creation, job control, and increased productivity expertise. The workshops include the following courses:

- **LPS Introduction Workshop.** This one-day workshop includes a technical overview of LPS features, system disk structure, operating system software, the system generation procedure, disk utilities, problem solving, and an introduction to command files. Hands-on experience includes configuring and generating a new software system and performing maintenance procedures using the LPS utility commands.
- **LPS Forms Description Language (FDL) Workshop.** This one-day workshop provides instruction on FDL commands, inserting logos and graphics, using the forms design ruler and quick reference card, coding and printing electronic forms, modifying a form to print variable data, and converting to a two-up format.
- **LPS Print Description Language (PDL) Workshop.** This three-day workshop provides lecture and hands-on practice for using PDL commands to identify the source and format of input to the LPS, using special processing options, defining how printed documents should be formatted, merging forms with variable data, specifying when and where various fonts, typestyles, and sizes should be used within a job, employing Dynamic Job Descriptor Entries (DJDEs), and creating and compiling Job Description Libraries (JDLs).
- **LPS Print Description Language (PDL) II Workshop.** This two-day workshop combines lecture and lab work to help students apply advanced PDL techniques in maximizing system productivity and developing new applications for the LPS.
- **LPS Command File Workshop.** This is a modularized two-day workshop that provides self-paced training on such activities as establishing menus, providing system security, effective file maintenance, merging variable data on electronic forms, simplifying accounting file information, manipulating files, creating new font files, effective disk management, and creating customized applications.

For detailed information about any of these courses, to enroll in workshops, or to order the self-study, call Xerox Customer Education at **1-800-445-5554**.

Fonts and supplies for installation

Consumable supplies, such as paper, dry ink, developer, and fuser lubricant, need to be ordered for your LPS.

A set of standard fonts is provided with your system. If nonstandard fonts are needed, they must be ordered from Xerox Font Services.

This section describes the fonts and supplies needed for installation. Your sales representative will help you place your initial order for fonts (if any) and supplies.

Reference Refer to the "Postinstallation" chapter for procedures on how to order fonts and supplies after initial installation.

Fonts

There are three classifications of fonts for your LPS:

- Standard fonts
- Licensed fonts
- Custom fonts.

Standard fonts Provided with your LPS operating system software is a library of over 250 standard 300 spots per inch (spi) fonts, referred to as the A03 font family.

Note: If you are installing a 4650 LPS, you are provided with five 600 spi font families in addition to the standard library of 300 spi fonts. There are three categories of 600 spi fonts available:

- Data center fonts
- Publishing fonts
- Interpress fonts.

Your sales representative will assist you in selecting the appropriate 600 spi font category for your 4650 LPS.

Licensed fonts In addition to the library of standard fonts delivered with your LPS, over 100 licensed fonts may be ordered from Xerox Font Services.

Custom fonts Custom fonts and graphic images, such as company logos and signatures, can be digitized by Xerox Font Services for use on your LPS.

Receiving fonts

The fonts provided by Xerox Font Services are provided on 5.25 inch double-sided, dual density diskettes, floppy disks (one disk may contain more than one font), 9-track, 1,600 bits per inch (bpi), unlabeled magnetic tape, 18-track cartridges, or 32-track cartridges. One tape may contain several fonts, each of which is a separate file.

Note: The 4650 comes standard with 600 spi fonts on magnetic tape or 32-track cartridge.

As with the other initial supplies, your sales representative assists you in determining your LPS font needs for installation. After installation, Xerox Font Services can help you order additional licensed and custom fonts.

Paper

Select your paper carefully; without the proper paper, the probability of paper jams and misfeeds increases.

Acceptable paper stocks and sizes

Your LPS can print on standard white, colored, predrilled, and preprinted (for example, letterhead and forms) paper, labels, and transparencies. They must meet the specifications set forth by Xerox for operability in the LPS.

Reference

Additional information about paper for your LPS can be found in *Helpful Facts About Paper*.

Paper weights and grade

For best results, use 20 pound/80 gsm (grams per square meter) bond xerographic grade paper. Xerox 4024 Dual Purpose Paper and Xerox 10 Series Dual Purpose Paper are specifically designed for optimal performance in your LPS.

Reference

Refer to the "Consumable supplies" table in the "Postinstallation" chapter for a list of papers and supplies.

Use paper within the following parameters:

Lightest: 20 pound/80 gsm

Heaviest: 110 pound/200 gsm

Your LPS accepts 8 1/2 by 11 inch, 8 1/2 by 14 inch, and A4 (210 by 297 mm) cut sheet paper.

Note: If you have a 4650 LPS, it is recommended that you use Xerox 10 Series, or other high-quality paper, to receive optimum quality for your applications.

Storing paper

Paper has a tendency to curl when exposed to the heat that is present inside xerographic equipment. Paper with low moisture content curls less. Paper with excessive moisture content has a tendency to jam because of the greater curl.

Note: The maximum recommended moisture content is 5.7%.

Paper is fed into the LPS with the long side as the leading edge. The grain should be parallel with the long side (long grain) for the most reliable feeding and stacking. Purchase long grain paper.

Keep these points in mind when preparing your paper storage area.

- Store paper in its own wrapper; do not leave it unwrapped or where it can be damaged by dampness or heat.
- Store paper on a flat surface and not on its side or edge.
- Store reams of paper in a closed cabinet.
- Always store paper in a cool, dry area.
- Store paper on pallets or shelves, not on the floor.
- Keep a supply of paper designed to last several hours in the same area as the printer to allow for the environmental stabilization of the paper.

Dry ink

Dry ink is the black powder which forms the image on the printed page. There are three cartridges of dry ink in each container. At least one container needs to be ordered and kept on hand at all times. The throw-away cartridges are changed easily by the operator with no mess. The consumption rate of dry ink is approximately one cartridge per 45,000 pages. Use only dry ink that is specified for use in your LPS.

Reference Refer to the "Consumable supplies" table in the "Postinstallation" chapter for information on how to order dry ink after initial installation.

Fuser lubricant

Fuser lubricant is a consumable item required by the LPS. At least one box (two tubes) needs to be ordered and kept on hand for installation by the service representative. The consumption rate of fuser lubricant is approximately one tube per 100,000 pages. The system holds up to three tubes when full and is refilled to capacity during each service call.

Reference Refer to the "Consumable supplies" table in the "Postinstallation" chapter for information on how to order fuser lubricant after initial installation.

Developer

Xerox developer has an effective life of approximately 500,000 pages per container. (Xerox developer is warranted by Xerox for 300,000 pages.) Developer also needs to be ordered and kept on hand. It is changed by a service representative. Use only developer specified for use in your LPS.

Reference Refer to the "Consumable supplies" table in the "Postinstallation" chapter for information on how to order developer after initial installation.

Floppy disks

Floppy disks are optional items that provide loading and backup of fonts, forms, and user files to and from the LPS system disk. The LPS accepts 5.25 inch double-sided, dual density disks. Best results are obtained with floppy disks that are not high-density or high-capacity.

Reference Refer to the "Consumable supplies" table in the "Postinstallation" chapter for information on how to order floppy disks after initial installation.

Stitcher wire

Stitcher wire is a consumable item for an LPS with the stitcher/stacker option. Stitcher wire reels need to be ordered and kept on hand. They are installed by your service representative or ACT-trained operators.

Reference Refer to the "Training" section of this chapter for information on training operators and the "Consumable supplies" table in the

“Postinstallation” chapter for information on how to order stitcher wire after initial installation.

Tapes

Each of the tape drives available with your 4050/4090/4650 LPS requires tapes of a different format.

26-track cartridge tapes	The optional 26-track tape drive uses 0.5 inch compatible cartridge tapes with a data capacity of 320 MB or 525 MB, depending on the choice of DC6320 or DC6525 tape cartridges. Both tapes are .25 inch ANSI compatible. Cartridges are not available from Xerox.
18-track cartridge tapes	The optional 18-track tape drive uses 0.5 inch IBM 3480 compatible cartridge tapes with a data capacity of 200 MB. Cartridges are not available from Xerox.
9-track magnetic tapes	The optional 9-track tape drive supports reel-to-reel 9-track 1600 bpi Phase Encoded (PE) and 6250 bpi Group Code Recording (GCR) encoded magnetic tapes.

Space planning templates

Dimensions and space requirements for LPS components are provided earlier in this chapter. The space planning templates are designed to simplify the space planning process by helping you create a floorplan for your LPS base components, particularly if you will have shared clearance space.

The easiest way to use the space planning templates is to remove the transparency located at the end of this chapter and move the templates around on the grid (also located at the end of this chapter) to find the optimum placement for your LPS components. Make sure you consider other pieces of equipment, such as storage cabinets and tables, when planning space for your LPS.

The templates are to scale with the grid; each square is equal to one foot. The curved dotted lines in the corners of the space perimeters indicate the corners that may be rounded off while still maintaining the required clearance space.

The templates provided are for the system controller and the various printer configurations. Make sure you allow space for optional equipment as appropriate. Your sales representative can help you plan space for additional components.

There are a number of factors to keep in mind when planning your site. These include:

- Clearance space requirements
- Cable lengths
- Efficiency of use.

Reference Refer to these sections in this chapter when considering the various factors in planning the appropriate location for your LPS.

Figure 1-16. Space planning templates

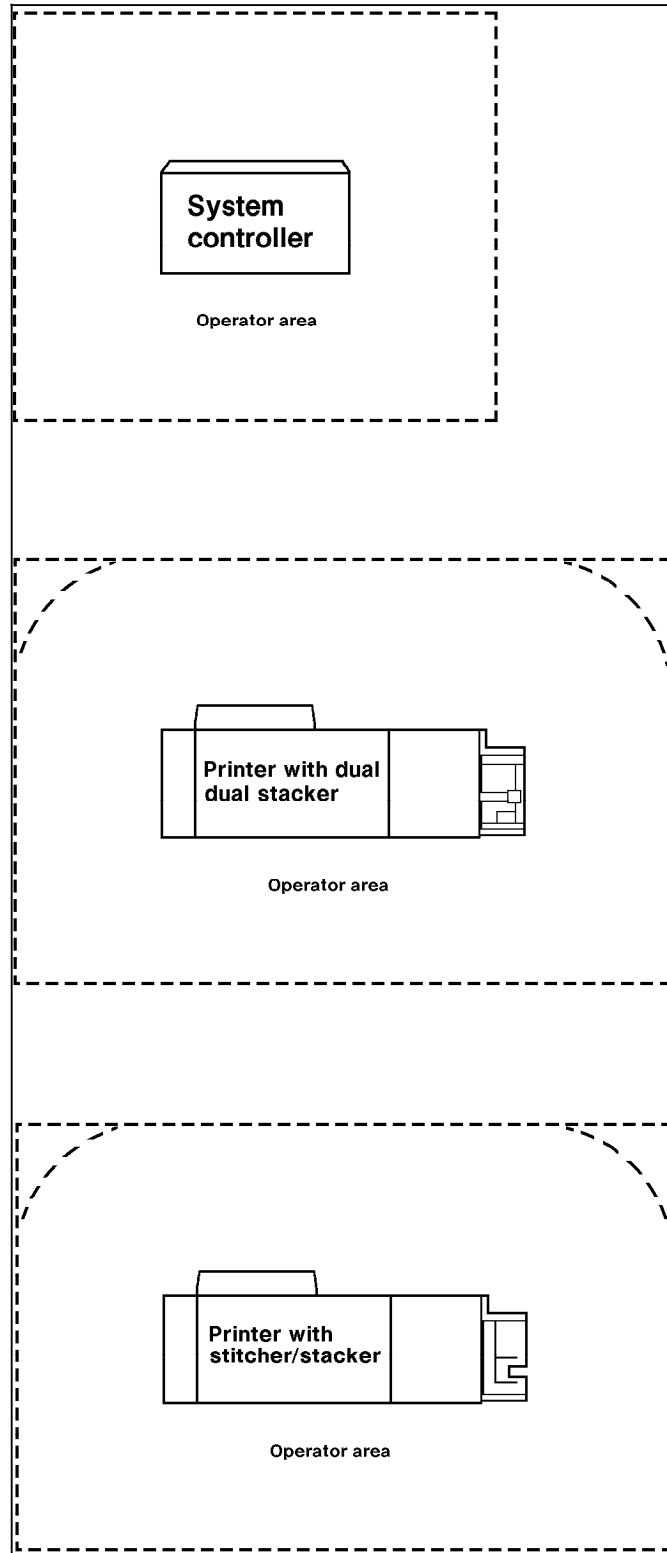

Figure 1-16. Space planning templates (continued)

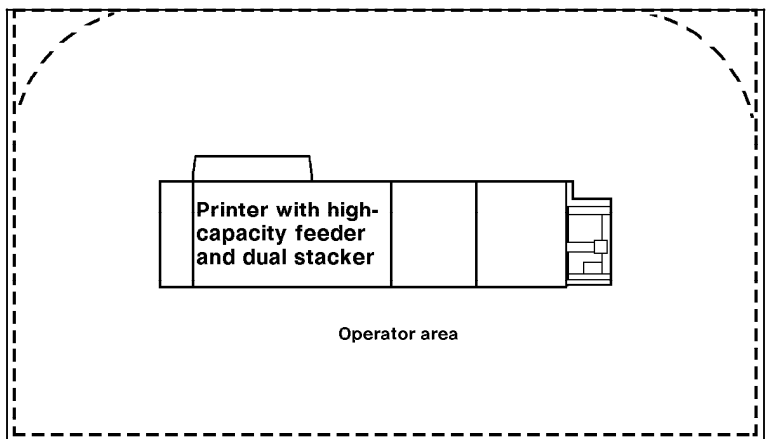
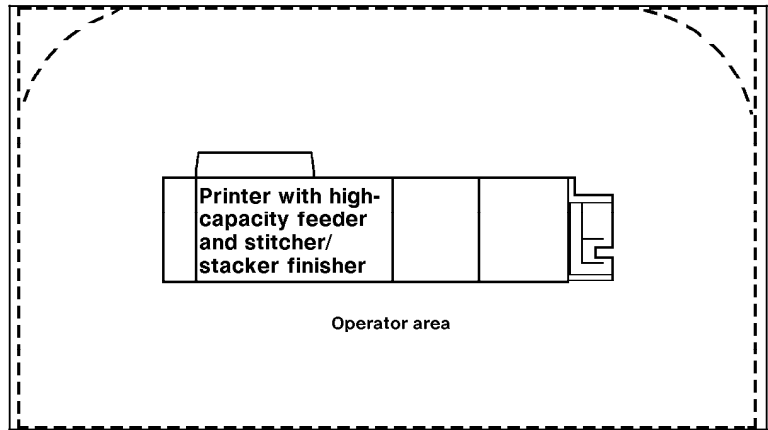
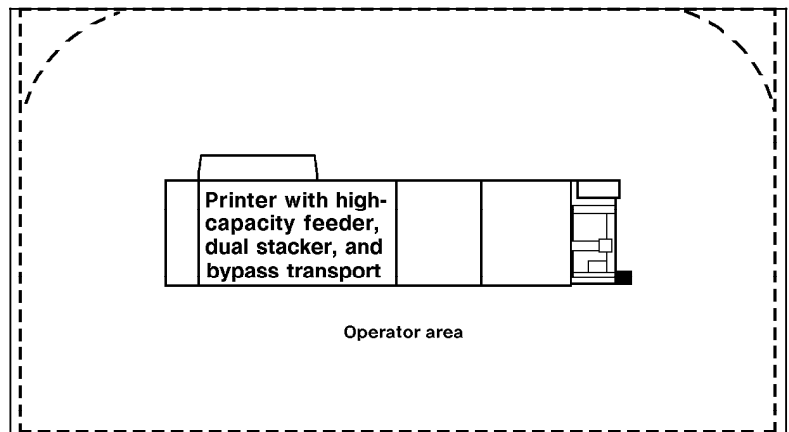
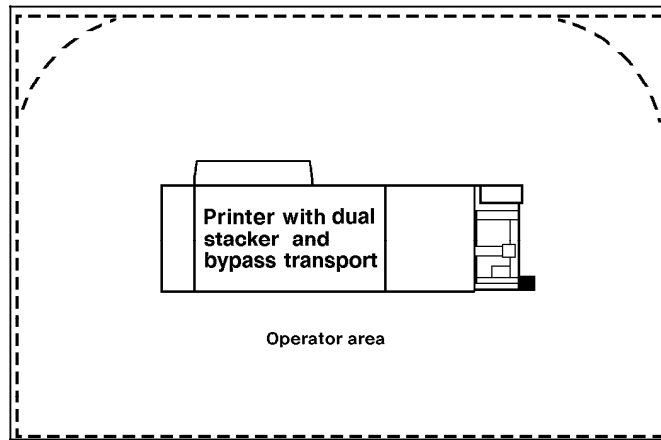

Figure 1-16. **Space planning templates (continued)**



This chapter provides a brief explanation of the installation process for your Laser Printing System (LPS).

Installation process

The installation process generally takes one to several days to complete. Equipment, software kits, and documentation kits may all arrive in one day or over the course of several days.

When all necessary items are in place, a team of Xerox personnel completes the installation of your LPS. Installation responsibilities are shared by sales and service representatives and analysts.

The installation process typically occurs in the following order:

- Equipment (hardware) and options are installed.
- LPS is "sysgened" and tested.
- System is placed online, if appropriate.
- Initial applications are loaded and sample jobs are run.
- Interface configurations are set (4450/MRP)
- Initial operator training is provided.

Installation responsibilities

Xerox is responsible for the physical installation of the LPS components and the loading of software and applications. You have the more general site responsibility of ensuring that the right personnel and supplies are available. Installation responsibilities are outlined in table 2-1.

Table 2-1. **Installation responsibilities**

Who	Responsibilities
Xerox	<ul style="list-style-type: none"> • Install the LPS. • Load the software and initial applications. • Train operator(s). • Review preventive maintenance schedules and service call procedures.
Customer	<ul style="list-style-type: none"> • Ensure that all needed supplies are on site. • Ensure that your system specialist is available during the loading of software and applications tapes. • Have the appropriate operators available for training. • Check the documentation and software kits for completeness. • Have test jobs ready to run, if desired.

Reference Refer to the "Installation planning checklist" in the "Preinstallation" chapter of this guide for a complete list of all installation responsibilities.

After the installation of your Laser Printing System (LPS), a number of ongoing tasks must be performed. These tasks may include all or some of the following:

- Placing service calls for hardware problems and obtaining assistance in solving application-related problems
- Identifying and implementing new applications
- Arranging additional operator training
- Overseeing routine customer maintenance and meter reporting
- Ordering additional fonts and documentation
- Maintaining an adequate inventory of consumable supplies.

Reference

Refer to the "Training" section of the "Preinstallation" chapter for information on training and workshops.

As installation coordinator, it is your responsibility to designate a person to perform these tasks.

This chapter describes these tasks and some of the Xerox support services available to you. Use the "Consumable supplies" table and "Supplies checklist" provided at the end of the chapter when ordering supplies.

Xerox support services

Xerox provides many services in support of your LPS. These services include the following:

- Xerox Printing Systems Customer Support Center
- The Xerox Connection
- Xerox Font Services
- Xerox Documentation and Software Services (XDSS)
- Xerox Supplies Order Service.

Detailed information about these services is described in this chapter.

Prior to installation, your Xerox sales representative is available to answer your questions about the products, services, or billing. If you need assistance in resolving applications-related problems or questions, contact the Xerox Customer Support Center. Your Xerox system can provide a variety of systems consulting services.

Routine maintenance

There are a number of routine maintenance tasks that must be performed to ensure maximum efficiency of your LPS. These tasks include the following:

- Adding dry ink
- Adding stitcher wire (with the stitcher/stacker option)
- Cleaning the tape and floppy disk drives
- Cleaning the terminal and the exterior surfaces of the system.

Step-by-step instructions on performing these routine maintenance tasks are contained in your *Xerox 4050/4090/4450/4650 LPS Operator Guide*. You need to decide how many operators are responsible for performing these maintenance tasks. Most maintenance procedures are covered in the initial operator training provided shortly after installation.

Note: Stitcher wire replacement is to be performed by operators who have completed Advanced Customer Training (ACT) only. Refer to the "Training" section of the "Preinstallation" chapter for additional information.

Meter reading and reporting

As print jobs are processed, firmware in the printer or software in the system controller accumulates, saves, and maintains usage data in its nonvolatile memory.

Sometime during the last five working days of each month, usage data needs to be reviewed and the information transmitted to Xerox for billing purposes. Refer to your *Xerox 4050/4090/4450/4650 LPS Operator Guide* for complete instructions on how to report meter readings.

Xerox Font Service

Numerous licensed fonts are available from Xerox Font Services. If you plan to use a font that is not a system font, place your order so that the font diskettes arrive before your LPS is installed. Fonts can be ordered on magnetic tape or diskette for downloading from your host computer system to the LPS.

Reference Refer to the "Fonts and supplies for installation" section of the "Preinstallation" chapter for more information on fonts.

How to order fonts in the United States

Call Xerox Font Services to place an order. The Xerox Font Services representative assists you in completing the necessary forms. The representative also answers your questions regarding literature, order status, or custom font specifications.

When dialing the appropriate toll-free number listed below, give your LPS serial number:

LPS serial number: _____

Call Xerox Font Services at **1-800-445-FONT** (3668).

Write to the following address to order fonts or to request information:

Xerox Corporation
Font Services ESCP-126
701 South Aviation Boulevard
El Segundo, California 90245

The following chart shows the approximate time it takes to receive your order. A Xerox Font Services representative can give you a more precise delivery schedule.

Approximate time to place an order before the day of installation is shown in table 3-1.

Table 3-1. **Ordering schedule**

Time	Fonts
6 weeks	Custom fonts and alterations of existing fonts (thinning, scaling, and so on)
5 business days	Logos, signatures
3 business days	Licensed standard fonts

How to order fonts in other countries

Contact your local Xerox sales representative to place an order. The Xerox representative assists you in completing the necessary forms. The representative also answers your questions regarding literature, order status, or custom font specifications.

Ordering documentation and software

Call the Xerox Document and Software Services (XDSS) at **1-800-445-5554** to order additional copies of the reference manuals or any of the other documents listed.

In the back of this book is a card to use for ordering the *Xerox Customer Documentation Catalog* that has a complete list and description of available Xerox documents.

Xerox Supplies Order Service

To order Xerox supplies within the United States, call the following toll-free number during business hours—8:00 a.m. to 6:00 p.m (Pacific Standard Time): **1-800-822-2200**.

In Canada, call your Xerox supply order representative between 7:30 a.m. and 7:00 p.m. (Eastern Standard Time) at the following toll free numbers:

733-9400 (in Toronto)
1-800-688-0133 (in Quebec)
1-800-668-0199 (in the rest of Canada)

Contact your local sales representative for orders in other locations.

How to order supplies

The Xerox supply order representative will ask you to supply the following information:

1. Your **Xerox customer order number** (supplied by your Xerox representative and/or included on your Xerox invoice).
2. Your **product model number**: (4050, 4090, 4450, or 4650)
3. **Purchase order number** (if that is the method of payment used by our company).
4. Your supply items:
 - **Description**
 - **Part number**
 - **Quantity**.

Reference

Refer to the following "Consumable supplies" table for a description and part numbers for each supply item.

Use the following "Supplies checklist" to prepare and record your order.

Consumable supplies table

Table 3-2 lists the supplies that are available for your LPS. Use this table to help you determine your supplies needs.

Table 3-2. Consumable supplies

Item	Description	Part Number
Paper	Xerox paper quantities are 10 reams (5,000 sheets) to a carton unless otherwise noted below.	
8.5 x 11 inch	4024 Dual Purpose Paper	3R721
A4	4024 Dual Purpose Paper	3R2594
8.5 x 14 inch	4024 Dual Purpose Paper	3R727
8.5 x 11 inch	4024 Dual Purpose Paper, 3-hole	3R723
8.5 x 11 inch	4024 Dual Purpose Paper, 3-hole*	3R2193
8.5 x 11 inch	4024 Dual Purpose Paper, 4-hole	3R1983
8.5 x 11 inch	4024 Dual Purpose Paper, 4-hole*	3R3008
8.5 x 11 inch	4024 Dual Purpose Paper, 7-hole	3R1984
8.5 x 11 inch	4024 Dual Purpose Paper, 7-hole*	3R3010
8.5 x 11 inch	4024 Smooth	3R2675
8.5 x 14 inch	4024 Smooth	3R2677
8.5 x 11 inch	Dual Purpose Colors, Blue	3R3052
8.5 x 11 inch	Dual Purpose Colors, Blue, 3-hole	3R3068
8.5 x 14 inch	Dual Purpose Colors, Blue, 3-hole	3R3084
8.5 x 11 inch	Dual Purpose Colors, Green	3R3056
8.5 x 11 inch	Dual Purpose Colors, Green, 3-hole	3R3072
8.5 x 14 inch	Dual Purpose Colors, Green	3R3088
8.5 x 11 inch	Dual Purpose Colors, Pink	3R3058
8.5 x 11 inch	Dual Purpose Colors, Pink, 3-hole	3R3074
8.5 x 14 inch	Dual Purpose Colors, Pink	3R3090
8.5 x 11 inch	Dual Purpose Colors, Yellow	3R3054
8.5 x 11 inch	Dual Purpose Colors, Yellow, 3-hole	3R3070
8.5 x 14 inch	Dual Purpose Colors, Yellow	3R3086
8.5 x 11 inch	Dual Purpose Colors, Buff	3R3060
8.5 x 11 inch	Dual Purpose Colors, Buff, 3-hole	3R3076
8.5 x 14 inch	Dual Purpose Colors, Buff	3R3092
8.5 x 11 inch	Dual Purpose Colors, Goldenrod	3R3062
8.5 x 11 inch	Dual Purpose Colors, Goldenrod, 3-hole	3R3078
8.5 x 14 inch	Dual Purpose Colors, Goldenrod	3R3094
8.5 x 11 inch	Dual Purpose Colors, Ivory	3R3064

Table 3-2. Consumable supplies (continued)

Item	Description	Part Number
8.5 x 11 inch	Dual Purpose Colors, Ivory, 3-hole	3R3080
8.5 x 14 inch	Dual Purpose Colors, Ivory	3R3096
8.5 x 11 inch	Dual Purpose Colors, Gray	3R3066
8.5 x 11 inch	Dual Purpose Colors, Gray, 3-hole	3R3802
8.5 x 14 inch	Dual Purpose Colors, Gray	3R3098
8.5 x 11 inch**	Dual Purpose Colors, Rainbow Pack 35,000 sheets/carton 250 sheets/pack)	3R3107
8.5 x 11 inch	10 Series Dual Purpose Paper	3R2950
8.5 x 11 inch	10 Series Dual Purpose Paper, 3-hole	3R2952
8.5 x 11 inch	10 Series Dual Purpose Paper, 3-hole*	3R3016
8.5 x 14 inch	10 Series Dual Purpose Paper	3R2954
8.5 x 11 inch	10 Series Smooth	3R54
8.5 x 14 inch	10 Series Smooth	3R83
Transparencies	Xerox transparencies are packaged 100 sheets to a box.	
8.5 x 11 inch	Clear, with a white strip on the edge	3R2780
	Removable strip	3R3108
	Paper backed	3R3028
Labels (Gummed)	Xerox labels are packaged 100 sheets to a box.	
8.5 x 11 inch	24 labels per sheet	3R2363
8.5 x 11 inch	8 labels per sheet	3R2364
8.5 x 11 inch	Custom form (uncut)	3R2365
Dry ink	Packaged 3 cartridges/carton. (Consumption rate is approximately one cartridge per 45,000 pages).	6R717
Developer	Packaged 1 container/carton. (Effective life is approximately one container per 500,000 pages).	5R302
Fuser lubricant	Packaged 2 tubes/carton. (Consumption rate is approximately one tube per 100,000 pages).	8R983
Stitcher wire	Packaged 1 reel per carton. (Consumption rate is approximately 32,000 stitches per reel).	8R1174
Floppy disks	Packaged 10 floppy disks per box. 5.25 inch, double-sided, dual density floppy disks.	11R66003
Cleaning supplies	Magnetic Head Cleaning Kit. Packaged 1 diskette per box.	9R980230
	Hub and transport cleaner	99P87486
	Foam-tipped swabs	99P87256
	Lint-free towels	35P2163

Table 3-3. **Supplies checklist**

Checklist: Supplies				
Use this checklist to help record the supplies you require, the date on which the order should be placed, and the actual date of the order.				
Item	Description and part number	Quantity	Date to order	Date ordered
Paper				
Transparencies				
Labels				
Dry ink				
Developer				
Fuser lubricant				
Stitcher wire				
Floppy disks				
Cleaning supplies				

Glossary

A3	International paper size measuring 297 by 420 mm or 11.69 by 16.54 inches.
A4	International paper size measuring 210 by 297 mm or 8.27 by 11.69 inches.
B4	International paper size measuring 250 by 353 mm or 9.84 by 13.9 inches.
batch processing	Process that allows for repetitive operations to be performed sequentially on batched data without much involvement from the computer operator.
BCD	Binary coded decimal.
bitmap	Visual representation of graphic images in which a bit defines a picture element (pixel) and a matrix of bits defines an image. For example, if a bit is 1, the corresponding pixel is printed.
blocking	Process of combining two or more records into a single block of data which can be moved, operated upon, stored, and so on, as a single unit by the computer.
block length	Number of characters or bytes contained in a block of data (the block is treated as a unit within the computer). Block length is usually invariable within a system and may be specified in units such as records, words, computer words, or characters.
BOF	Bottom-of-form.
BOT	Beginning-of-tape.
bpi	Bits per inch.
CCID	Character Code Identifier. Code associated with the universal identifier "Xerox" to indicate the version of the Xerox character code standard used to code Interpress strings.
character set	Set of all characters defined in a font, including alphabetic, numeric, and special characters such as symbols.
cluster	Group of related feeder trays, usually containing the same size and type of paper (stock). Each cluster has a name, consisting of one to six alphanumeric characters.

CME	Entry modifying the output printing characteristics of a report on a copy-to-copy basis.
compiler	Software that translates instructions written in high-level language into machine language for execution by a system.
Copy Modification Entry	See <i>CME</i> .
copy-sensitive	Job in which multiple copies of a report contain different data, such as paychecks and banking statements.
cpi	Characters per inch.
default	Value assigned to a field by the system if no input is received from the operator. You can change the default value of a field.
DJDE	Dynamic Job Descriptor Entry. Command within an input data stream used to modify the printing environment dynamically.
dot	Picture element (pixel) imaged by a printer. The number of dots imaged per inch measures printer resolution, for example, 300 dots per inch (dpi). See also <i>spot</i> .
dpi	Dots per inch. Indicates the number of dots per inch displayed on a terminal screen or printed to form a character or graphic.
dry ink	Minute particles of resin and carbon black that can accept an electrical charge and create images. Resin and carbon black or color pigment toner are combined with developer to form the dry ink.
duplex	1. Ability of a data communications system to send and receive information simultaneously. 2. In printing, duplex means printing on both sides of the paper.
Dynamic Job Descriptor Entry	See <i>DJDE</i> .
edgemarking	Use of graphic objects (usually lines or boxes) that bleed off the edge of the physical page. See also <i>physical page</i> .
embedded blanks	Blank spaces within a command line.
ENET	Ethernet network.
EOT	End of tape.
Ethernet	Xerox local area network (LAN) that allows transmission of data by cable from one device to another.

FCB	Forms Control Buffer. Controls the vertical format of printed output.
FCP	File Control Parameter.
FCU	File Conversion Utility.
FDL	Forms Description language. LPS-resident source language used to design electronic forms. See also <i>FSL</i> and <i>form</i> .
FDR	File directory.
FIS	Font Interchange Standard. Defines the digital representation of fonts and character metrics for the generation of an entire series of Interpress fonts.
floating accent	Nonspacing accent characters that can be combined with characters and printed as a composite.
font	Complete set of characters of a particular font family having the same point size, weight, stress, and orientation.
Font Interchange Standard	See <i>FIS</i> .
form	1. Compiled .FSL file. 2. Specific arrangement of lines, text, and graphics stored in an electronic version. Forms can be printed without variable data or merged with variable data during the printing process. See also <i>FDL</i> and <i>FSL</i> .
Forms Control Buffer	See <i>FCB</i> .
Forms Description Language	See <i>FDL</i> .
Forms Source Library	See <i>FSL</i> .
FSL	Forms Source Library. Uncompiled collection of user-created files containing FDL commands. See also <i>FDL</i> and <i>form</i> .
hexadecimal	Numbering system with a base of 16. The numbers 10 through 15 are represented by A through F.
highlight color	Printing with black plus another color. A range of colors, tints, and shades is printed by varying the percentage of black dots, colored dots, and the white space between the dots.
HIP	Host Interface Processor.
image area	Area on a physical page that may contain text or graphics.

initialize	1. To prepare a blank diskette so it can accept data. This is usually accomplished when a program is booted. 2. To set all information in a computer system to its starting values.
Interpress	Industry-standard page description language developed by Xerox. Interpress documents can be printed on any sufficiently powerful printer equipped with Interpress print software.
JCB	Job Control Block.
JCL	Job Control Language.
JDE	Job Descriptor Entry. Collection of job descriptions.
JDL	Job Description Library. Collection of compiled job descriptions. See also <i>JSL</i> .
JID	Job Identifier.
job	Synonymous with a START command, a job is a group of print data sets called reports. A job may contain one or multiple reports.
job control	Program called into storage to prepare each job or job step to be run.
Job Descriptor Entry	See <i>JDE</i> .
Job Descriptor Library	See <i>JDL</i> .
job management	Collective functions of job scheduling and command processing.
Job Source Library	See <i>JSL</i> .
JSL	Job Source Library. Collection of uncompiled job descriptions. See also <i>JDE</i> and <i>JDL</i> .
keyword	Required part of a command.
label	Reference to a file saved on tape or disk, a record indicating the file name or date created, or other control information.
landscape	Orientation in which text and images are positioned parallel to the long edge of the paper.
legal size	Paper size measuring 8.5 by 14 inches or 216 by 356 mm.
letter size	Paper size measuring 8.5 by 11 inches or 216 by 279 mm.

line feed	Control character that (unless set to be interpreted as a line end) causes the printing system to begin printing in the current character position of the next line.
literal	Alphanumeric character beginning with a letter, including an asterisk, period, colon, or slash, and not enclosed in single quotes.
logical page	In Xerox printing systems, a logical page is a formatted page that is smaller than the physical page. A logical page is defined by an origin, thus allowing more than one logical page to be placed on a physical page.
lpi	Lines per inch.
LPS	Laser printing system.
mask	Selection of bits from a storage unit by use of an instruction that eliminates the other bits in the unit. In accessing files, a file name mask is used to reference one or more files with similar file-id (identifier) syntax. In Interpress, a mask serves as a template, indicating the shape and position of an object on a page.
metacode	Method of controlling the image generator. The character dispatcher uses these codes to generate scan line information. This information is sent in the form of character specifications to the image generator, which uses it to compose the bit stream that modulates the laser. Also called native mode.
monochrome	Printing in one color only.
nesting	Subroutine or set of data, such as a comment, contained sequentially within another set of data.
object file	Source file converted into machine language (binary code).
octal	System of representing numbers based on 8.
offset	To place printed output sets in slightly different positions from each other in an output bin for easy separation of collated sets.
operand	That which is acted upon, for example, data, in an operation or process.
operating system	Software that controls the low-level tasks in a computer system, such as input or output and memory management. The operating system is always running when the computer is active.

orientation	In reference to image area, describes whether the printed lines are parallel to the long edge of the paper (landscape) or the short edge of the paper (portrait).
origin	In reference to image area, the upper left corner of a sheet.
overprint ratio	Maximum number of variable data and form characters that can be intersected by a single scan line.
packet	A group of DJDE records terminated by an END command.
page end	Command character (form feed) to terminate the current page.
palette	Predefined set of colors or inks. Different versions are provided with the printer and with host- or PC-based application software.
parameter	Part of a command, other than the keyword. See <i>keyword</i> .
parse	To read or interpret a command; to build up a parameter list from information within a command.
PCC	Printer Carriage Control.
PDE	Page Description Entry.
PDL	Print Description Language. Language used to describe printing jobs to a laser printing system. PDL describes the input (type, format, characteristics), performs the processing functions (logical processing), and describes the output (type, format, font selection, accounting options).
PE	Phase encoded.
physical page	Actual page size your printer uses to print a form.
pitch	Width of a fixed-pitch font expressed in characters per horizontal inch.
pixel	Acronym for picture element. Smallest addressable point of a bitmapped screen that can be independently assigned color and intensity.
point	In Xerox laser printing systems, a unit of measurement equal to 0.0139 inch. Points are always used to express type, size, and leading. There are 12 points to a pica and about 72 points to an inch.
portrait	Orientation in which text and images are positioned parallel to the short edge of the paper.

ppm	Pages per minute.
PQA	Print quality adjustment.
Print Description Language	See <i>PDL</i> .
print file	Portion of the system disk memory (up to 4 MB) reserved for temporary storage of formatted pages for printing. Pages are retained until they are delivered to the output tray.
PSC	Printer Subsystem Controller
query	Request for data or other information, entered by an operator while the system is processing.
record	A line of data as defined in the RECORD command.
report	A single output data set, delimited by an RSTACK command or as a file. In setting a separation boundary, reports are subsets of a job.
resolution	Number of dots per inch (dpi) or spots per inch (spi). The greater the number of dots, the higher the resolution and the clearer the image. The terms dots, spots, and pixels are synonymous.
scale	To adjust font or image size according to given proportions.
sequential	1. In numeric sequence, usually in ascending order. 2. A file structure in which records are written one after another and cannot be randomly accessed.
set	Multiple copies of the same report.
simplex printing	Printing on one side of the page.
spi	Spots per inch. See <i>resolution</i> .
spot	A picture element imaged by the printer. Synonymous with <i>dot</i> and <i>pixel</i> .
statement	Detailed instructions in a program step, written according to specific rules called syntax.
stock	User-defined name in the JSL that specifies a certain type of paper for printing a job.
stockset	Collection of stocks to be used on a print job. See also <i>stock</i> .

string	Connected sequence of alphanumeric characters treated as one unit of data by a program.
syntax	Rules governing the structure of expressions in a programming language.
system page	Maximum area in which text and graphics can be imaged on a printing system.
tape density	Expression of the format of a magnetic tape measured in number of bytes that can be stored per inch of tape.
TOF	Top of form.
two-up	Printing two logical pages on one side of a physical page.
UCSB	Universal Character Set Buffer.
UCS	Universal Character Set
variable data	Changeable information which is merged with a standard document to create specialized or personalized versions of that document. Variable data is not a part of a form design, but varies from page to page.
virtual page	Page area selected by a forms designer for printing.
vpos	Vertical positioning.
wildcard	Character (usually an asterisk *) which can be inserted into a command string to indicate that it may represent one or more characters in that position.
xdot	Unit of measurement representing a fraction of an inch. May also be referred to as a picture element (pixel) or spot; for example, 1/600 spots per inch (spi).
xerographic mode	Either of two possible printer configurations: 1. Black mode which allows printing with black dry ink only. 2. Highlight mode which enables both highlight color and black printing.
XNS	Xerox Network Systems.
XPAF, XPF	Xerox Printer Access Facility.

Numerals

180 cartridge tape system, 1-21 to 1-22
9-track magnetic tape drive, 1-7

A

activities, 1-2

B

bypass transport, 1-13

C

cable

lengths, 1-20

location, 1-20

requirements, 1-19 to 1-20

channel connection, see *interface requirements*

cleaning supplies, 3-6

clearance, 1-13

consumable supplies, see *supplies*

customer responsibilities, see *responsibilities*

Customer Support Center, 3-1

D

DEC, 1-23 to 1-26

delivery access, 1-16

developer, 1-30, 3-6

Digital Equipment Corp, see *DEC*

dimensions, see *system controller* or *printer*

documentation, 1-26

dry ink, 1-30, 3-6

dual

feeder, 1-8, 1-9

stacker, 1-8, 1-10, 1-12

E

efficiency of use, 1-15

electrical requirements, 1-18 to 1-19

environmental requirements, 1-18 to 1-19

F

floppy disks, 1-30, 3-6

fonts, 1-27 to 1-28

fuser lubricant, 1-30, 3-6

H

high capacity feeder, 1-10, 1-11

I

IBM host connection, 1-23

installation, v, 1-1, 1-5, 2-1

installation planning checklist, 1-3 to 1-5

interface requirements, 1-22

L

labels, 3-6

M

meter reading and reporting, 3-2

O

ordering

documentation, 3-3

software, 3-3

supplies, 3-3 to 3-4

P

paper, 1-29, 3-5 to 3-6

personnel, 1-2

planning checklist, installation, see *installation planning checklist*

postinstallation, v, 1-5

preinstallation, v

printer, 1-8 to 1-13

R

responsibilities, 1-1 to 1-2, 2-1

routine maintenance, 3-2

S

service, 1-1

shared space, 1-14

site selection, 1-1, 1-4

space planning templates, 1-31 to 1-37

space requirements, 1-5 to 1-13

stitcher/stacker, 1-9, 1-11, 1-30

stitcher wire, 1-30, 3-6

supplies, 1-4, 1-27 to 1-31, 3-5 to 3-7

support, 1-1, 3-1

system controller, 1-6 to 1-7

T

tapes, 1-31

terminal requirements, 1-15

third party interface connection, see *interface requirements*

training, 1-1, 1-2, 1-26 to 1-27

transparencies, 3-6

X

Xerox Font Service, 3-2 to 3-3

Xerox support services, 3-1